



TAURUS

GARAGE DOOR AUTOMATION

www.masterware.co.za



WARNING: IT IS VITAL FOR THE SAFETY OF ALL PERSONS INSTALLING AND USING THIS OPENER TO FOLLOW THE INSTALLATION INSTRUCTIONS AND SAFETY WARNINGS. FAILURE TO COMPLY MAY RESULT IN SERIOUS PERSONAL INJURY AND/OR PROPERTY DAMAGE AND FAILURE OF THE OPENER SYSTEM.

INSTALLATION & OWNERS MANUAL



CUNNINGHAM
DOOR CREATIONS



1.Functions

Micro intellectual control — One button to control open, stop and close.

The light is on while opening or closing the door, three minutes later the light is off automatically. The unit running is controlled by computer program. Test the force of open or close the door, the optional functions are photo beam, auto-close, lock door, etc. The door pauses momentarily then rebounds when it reaches the hinders on the closing way. The protecting functions are overload, over hot or low power input, etc.

DC motor — Low noise, soft start, slow stopping to protect the unit and make sure it can be used for a long time.

LED display — Working situation can be shown on the LED screen.

Decoding — Rolling code.

Manual Disengagement— Open and close the door by hand without power.

Optional Functions — Photo beam, battery backup, wall button and flash light.

WARNING

Do not operate this opener unless you are trained and authorized.

If you have questions, please call professionals.

2. Technical Specifications

Power input	230V 50/60Hz	Reception	433.92MHz
Motor	24VDC	Decoding	Rolling code
Working temperature	-20~40℃	Transmitter	27A 12V Battery
Relative Humidity	≅ 90%	Globe	LED
Open and close force	600N, 800N, 1000N, 1200N	Courtesy light	3 minutes

3. Installation

3.1 Recommended Tools

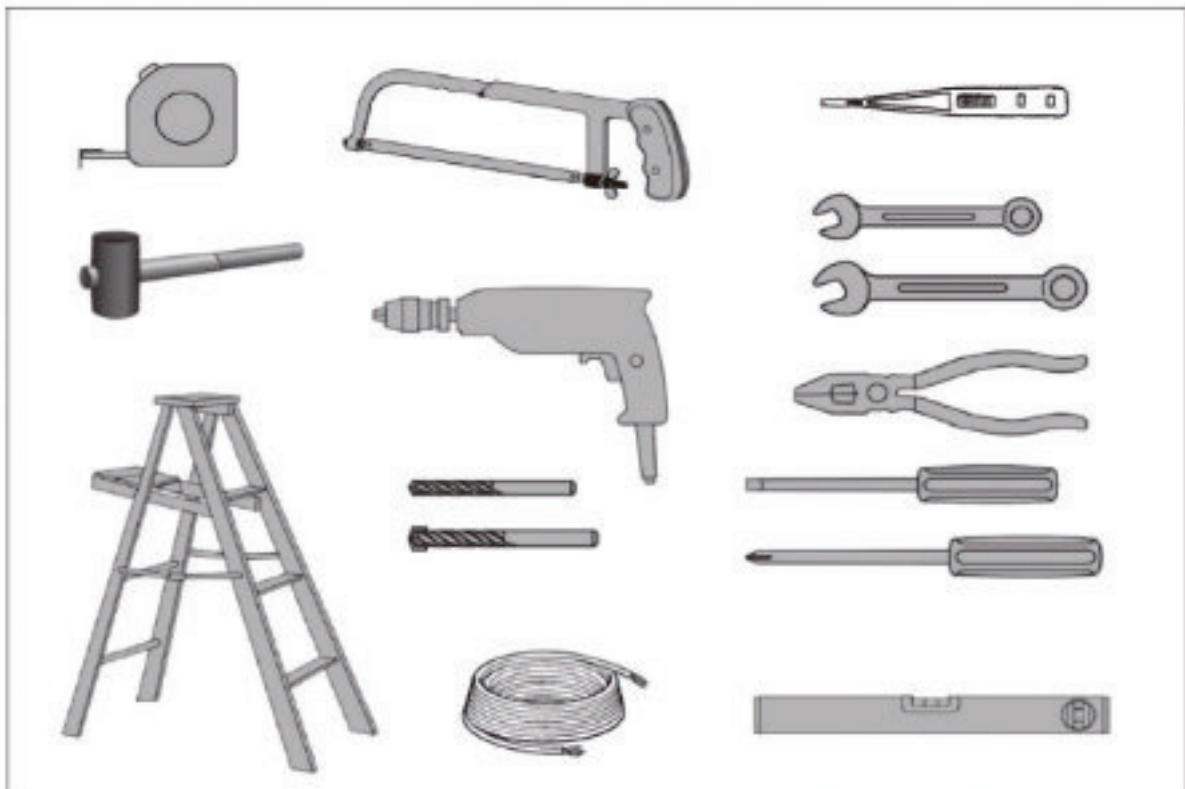

3.2 Installing the Operator and Rail

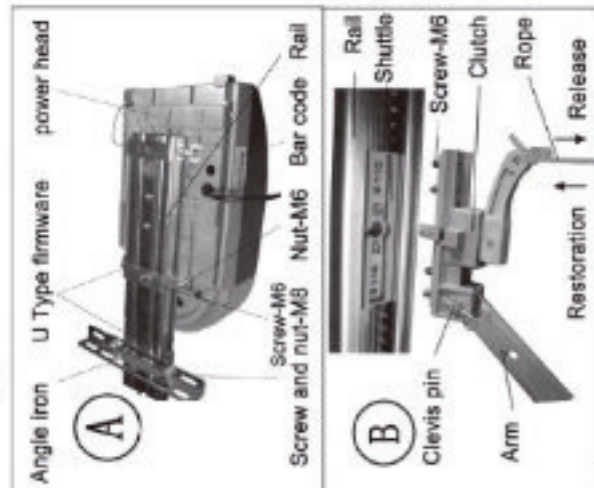
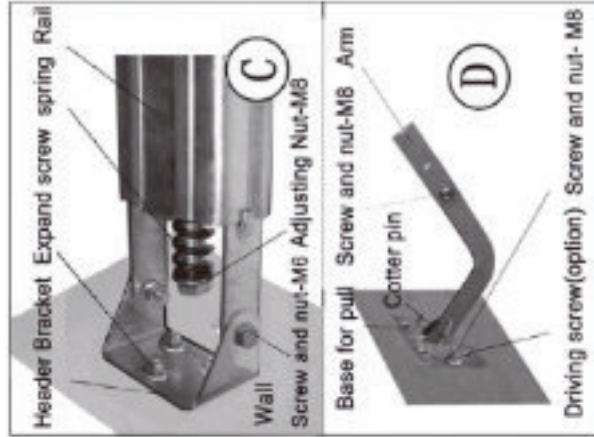
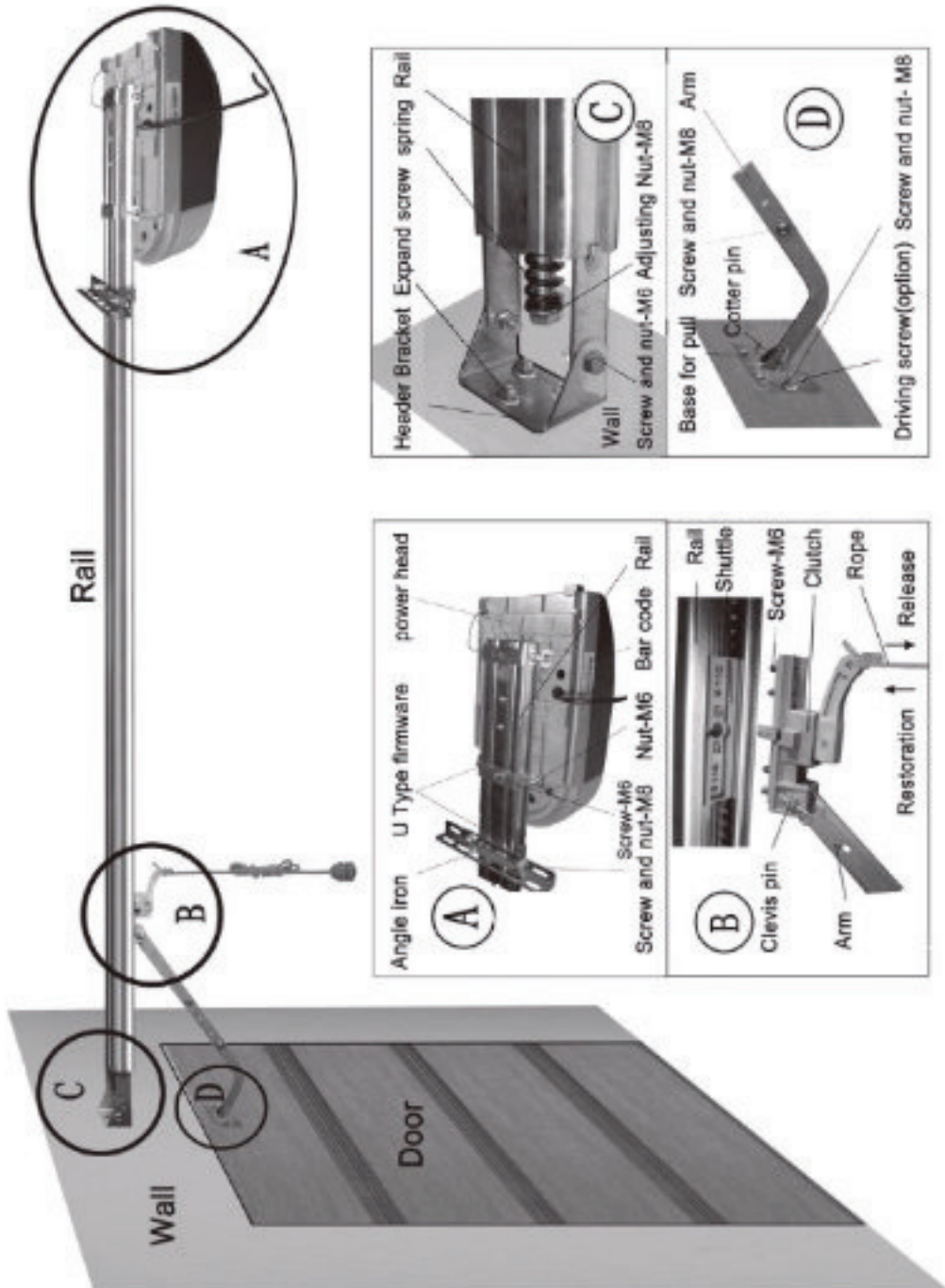



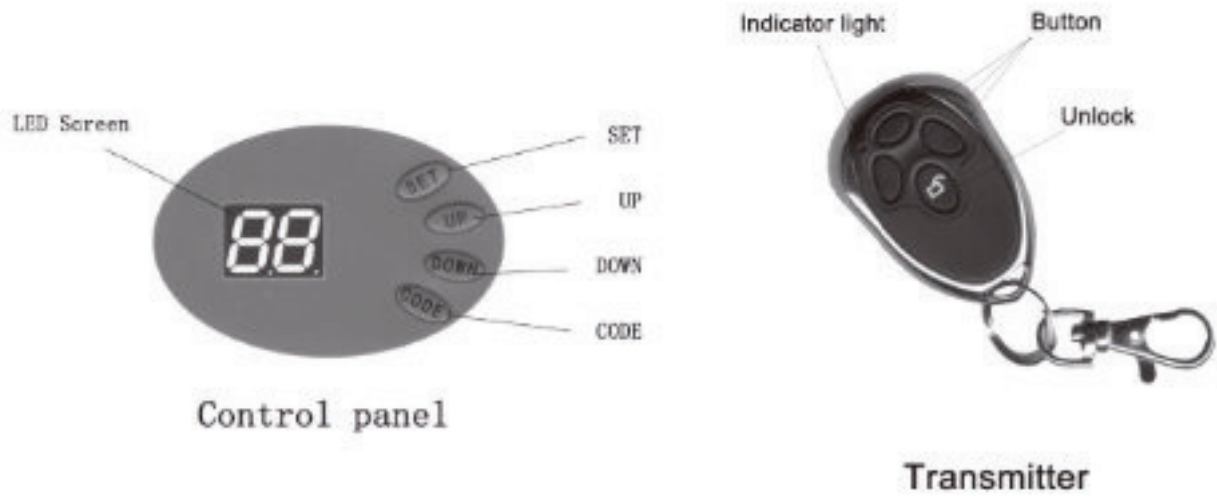



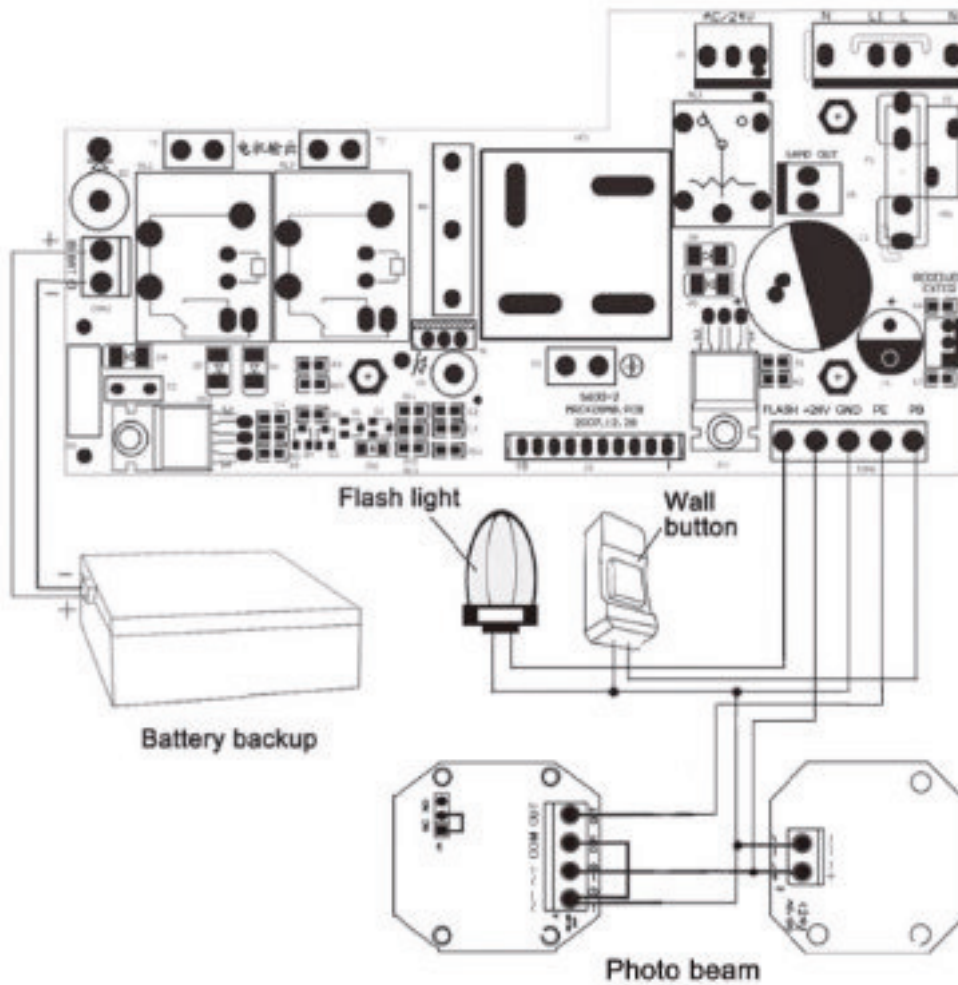



4. Control panel and Transmitter



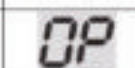
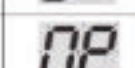
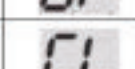
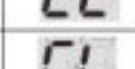
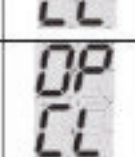

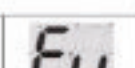
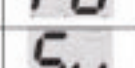
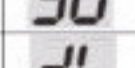

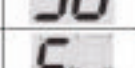
5. Optional Terminals and Connections







6. Programming the Operator

6.1	Preparing	
6.1.1	Keep trolley locked, Pull and push the door by hand, make sure the trolley connects with the shuttle.	
6.1.2	Turn on the power, the courtesy light is on for several seconds, at the same time, the LED displays the number from 99 to 11. Then the operator turns to standby situation.	
6.1.3	At last, it displays "- -".	
6.2	Setting Open and Close Positions	
6.2.1	Press and hold SET until it displays "P1".	
6.2.2	Press SET, it displays "OP".	
6.2.3	Then press and hold UP, it flashes "OP".	
6.2.4	When the door has reached the open position, press SET, It displays "CL".	
6.2.5	Then press and hold DOWN, it flashes "CL". When the door has reached the closed position, press SET.	
6.2.6	The door opens and closes automatically to map the open and close sensitivity force requirements.	
6.2.7	It displays "- -" to show setting is complete.	
6.3	Self Learning Transmitter	
6.3.1	When the unit has stored 20 codes, it flashes "Fu", or preventing coding mistakes, it is necessary to cancel all the stored codes.	
6.3.2	Press and hold CODE, it displays "Su".	
6.3.3	Hold more than 8 seconds, it flashes "dL", all the codes were cancelled.	
6.4	Adding or Changing Transmitters	
6.4.1	Press CODE, it displays "Su".	
6.4.2	Press a button on the transmitter, then release and press the same button again, "Su" flashes,	
6.4.3	Then it displays "- -" to show setting is complete. Repeat up steps to code a maximum of 20 different transmitters' and/or buttons.	

6.5	Force Adjustments	
6.5.1	Press and hold SET, it displays "P1".	P1
6.5.2	Press UP once, it displays "P2".	P2
6.5.3	Press SET once again, it will show the current situation. Press UP to increase the force one degree or press DOWN to decrease one degree. Maximum degree is "F9", minimum is "F1".	F9 F1
6.5.4	Press SET to confirm. The default setting is "F5".	F5
6.5.5	 After finishing all the setting, please check the force to make safe.	
6.6	Photo Beam	
6.6.1	Press and hold SET, it displays " P1" .	P1
6.6.2	Press UP twice, it displays "P3" .	P3
6.6.3	Press SET to show current situation. Press UP once it displays "H1", the photo beam is enabled. Press down once, It displays "H0", the photo beam is disabled. Press SET to confirm and quit.	H0 H1
6.6.4	 If you do not use photo beam device, please make sure it displays" H0", to close this function.	
6.7	Auto-Close ON/OFF	
6.7.1	Press and hold SET, it displays "P1".	P1
6.7.2	Press UP three times, it displays "P4".	P4
6.7.3	Press SET to show current situation. Press UP to increase the auto-close one minute or press DOWN to decrease one minute. Maximum degree is "b9" , minimum is "b0". Press SET to confirm.	b0 b9
6.7.4	 The default setting is "b0", "b0" shows auto-close off. This function works when the door reaches the open position.	
6.8	Lock Door	
6.8.1	Press and hold SET, it displays "P1".	P1
6.8.2	Press UP four times, it displays "P5" .	P5
6.8.3	Press SET to show current situation. Press UP, it displays "Lc ", lock door function works or press DOWN, It displays "uL", lock door function doesn't work. Press SET to confirm the function you need.	Lc uL
6.8.4	 When you use uncovered transmitters, it is recommended using lock door function. This function works when the door reaches the closed position, you can't open the door until press the "unlock" button first.	

7. Owners' Gui

7.1		Attention in use	
7.1.1		At the first time of using the door, please test the driving system to see if it moves well. (Test method: unlock the trolley, pull and push the door by hand.)	
7.1.2		Connected with the appropriate power and socket by professionals, and connected the earthing wire with earth.	
7.1.3		Using the transmitters in your sight. Do not stand or walk under a moving door. The transmitters should be out of reaching of children.	
7.1.4		Make sure the door out off fire, moisture, electromagnetism and some other places.	
7.1.5		Check at least twice a year to make sure the door is properly balanced and that all working parts are in good working condition. Adjust the tensile force of chain. Add suitable amount of lubricant to the active.	
7.2		Examination Guide	
7.2.1	Problem	Causes	Solution
7.2.2	The chain is noisy.	The chain is too loose.	Adjust nut-M8 referring to 3.2.C.
7.2.3	The motor does not work.	The socket is not well connect or the fuse is broken.	Check the socket or replace the fuse.
7.2.4	After setting open and close positions, the motor does not work.	The screws of fixing the Hall components are loose or program mistakes.	Tighten the screws or resetting open and close
7.2.5	The door can't be closed.	Photo beam function works.	Cancel the photo beam function, referring to 6.6.
7.2.6	The wall button works well, but the transmitter doesn't work.	No transmitter learning or transmitter battery is power off.	Code referring to 6.4 or change new transmitter battery.
7.2.7	Transmitter distance is too short.	The transmitter battery is nearly power off.	Change new battery

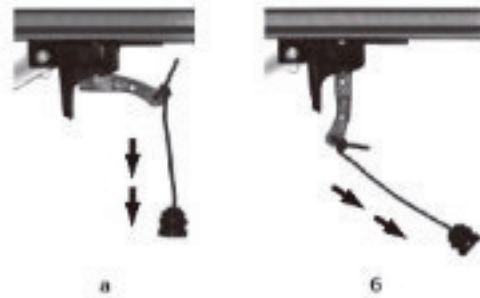

Fig. 3. Manual unblocking of the carriage



In the process of unblocking there can be uncontrolled movement of doors:

- if the door spring are loose or broken;
- if the doors are not balanced;
- if the doors are opened manually the carriage can collide with the drive (during building works limit the doors run in the opening direction);
- in the unblocked position doors can be moved only with medium speed!

- the appliance is not to be used by children or persons with reduced physical, sensory or mental capabilities, or lack of experience and knowledge, unless they have been given supervision or instruction
- children being supervised not to play with the appliance

If the supply cord is damaged, it must be replaced by the manufacturer, its service agent or similarly qualified persons in order to avoid a hazard.

WARNING: Important safety instructions. It is important for the safety of persons to follow all instructions. Save these instructions.

- do not allow children to play with door controls. Keep remote controls away from children;
- watch the moving door and keep people away until the door is completely opened or closed;
- take care when operating the manual release since an open door may fall rapidly due to weak or broken springs, or being out of balance;
- frequently examine the installation, in particular check cables, springs and mountings for signs of wear, damage or imbalance. Do not use if repair or adjustment is needed since a fault in the installation or an incorrectly balanced door may cause injury;
- each month check that the drive reverses when the door contacts a 50 mm high object placed on the floor. Adjust if necessary and recheck since an incorrect adjustment may present a hazard (for drives incorporating an entrapment protection system depending on contact with the bottom edge of the door) ;
- details on how to use the manual release;
- information concerning the adjustment of the door and drive.

WARNING: Important safety instructions. Follow all instructions since incorrect installation can lead to severe injury.

- before installing the drive, remove all unnecessary ropes or chains and disable any equipment, such as locks, not needed for powered operation;
- before installing the drive, check that the door is in good mechanical condition, correctly balanced and opens and closes properly;
- install the actuating member for the manual release at a height less than 1,8 m;
- permanently fix the labels warning against entrapment in a prominent place or near any fixed controls;
- permanently fix the label concerning the manual release adjacent to its actuating member;

ENVIRONMENT FRIENDLY DISPOSAL



You can help protect the environment!
Please remember to respect the local regulations:
hand in the non-working electrical equipments to
an appropriate waste disposal center.